

Corp de iluminat stradal cu LED:  
Street lighting with LED:

CRIOTEK 02 LED

Instructiuni de montare si exploatare  
Mounting and operating instructions  
Instructions de montage  
Montageanleitung

-40..+45°C IP66  $S_V=0,054m^2$  230V 50/60Hz

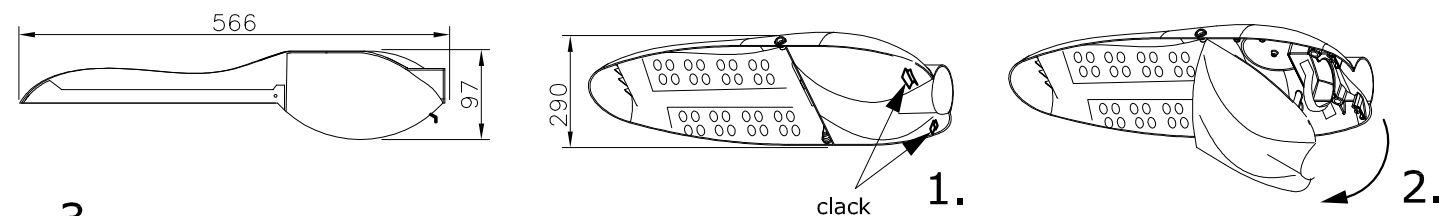

3.

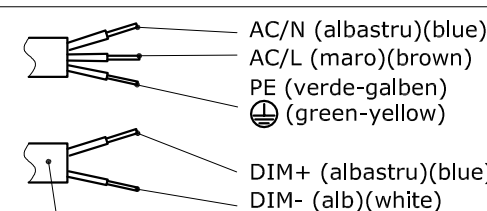

Se recomanda conectarea produsului la retea folosind conector  $\geq IP66$

It is recommended to connect the product using  $\geq IP66$  connector

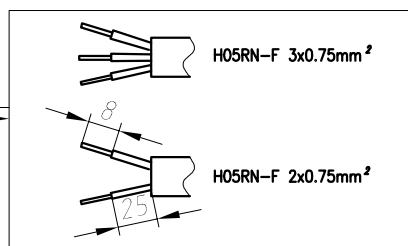

FUNCTII DE DIMMARE/ DIMMING FUNCTIONS

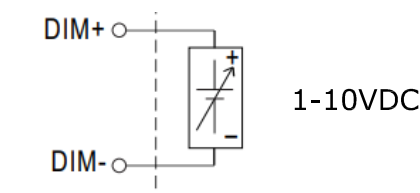

1-10VDC



semnal PWM  
PWM signal

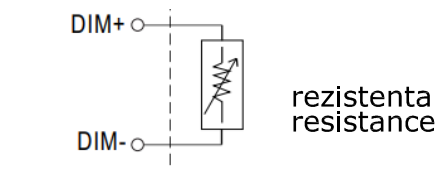

rezistenta  
resistance

Surubul se însurubeaza la un cuplu de 12,5 Nm.  
The screw screwing to a torque of 12.5 Nm.

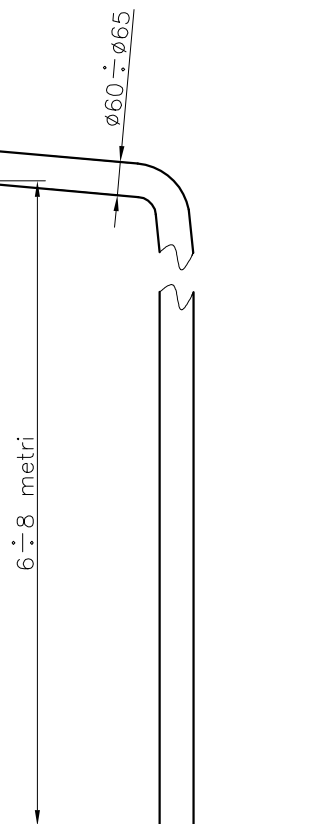

Atentie, risc de soc electric!  
Toate operatiile de montare si intretinere in exploatare se vor efectua in lipsa tensiunii electrice si numai de catre persoane autorizate!  
Sursa de lumina continuta in acest corp de iluminat va fi inlocuita numai de producator sau de agentul sau de service sau de o persoana calificata similara.  
Caution, risk of electric shock!  
All installation and maintenance operations will be performed in absence of operating voltage and only by authorized personnel!  
The light source contained in this luminaire shall only be replaced by the manufacturer or his service agent or a similar qualified person.

Acest simbol aplicat pe produs este in conformitate cu Directiva Europeana 2002/96/CE, privind deseurile echipamentelor electrice si electronice rezultate din dezmembrarea produselor uzate si indica faptul ca produsul face obiectul unei colectari separate. Pentru prevenirea distrugerii mediului inconjurator si sanatatii umane, va rugam sa nu eliminati acest produs ca deșeu nesortat. In vederea unei reciclari sigure din punct de vedere al mediului, utilizatorii de echipamente electrice si electronice trebuie sa predea deseurile acestora la punctele de colectare selectiva special amenajate de catre autoritatile administratiei publice locale.  
This symbol applied on the product complies with European Directive 2002/96/EC, regarding electrical and electronic waste products resulting from the dismantling and indicates that the product has a separate collection. To prevent the damages to the environment and human health, do not dispose of this product as unsorted waste. For a safe recycling, the electric and electronic equipment end-users must contact the local authorities for details concerning a safe recycling.

Corp de iluminat stradal cu LED:  
Street lighting with LED:

CRIOTEK 02 LED

Instructiuni de montare si exploatare  
Mounting and operating instructions  
Instructions de montage  
Montageanleitung

-40..+45°C IP66  $S_V=0,054m^2$  230V 50/60Hz

CONECTARE PRODUS FOLOSIND CONECTOR  
CONNECT THE PRODUCT USING CONNECTOR

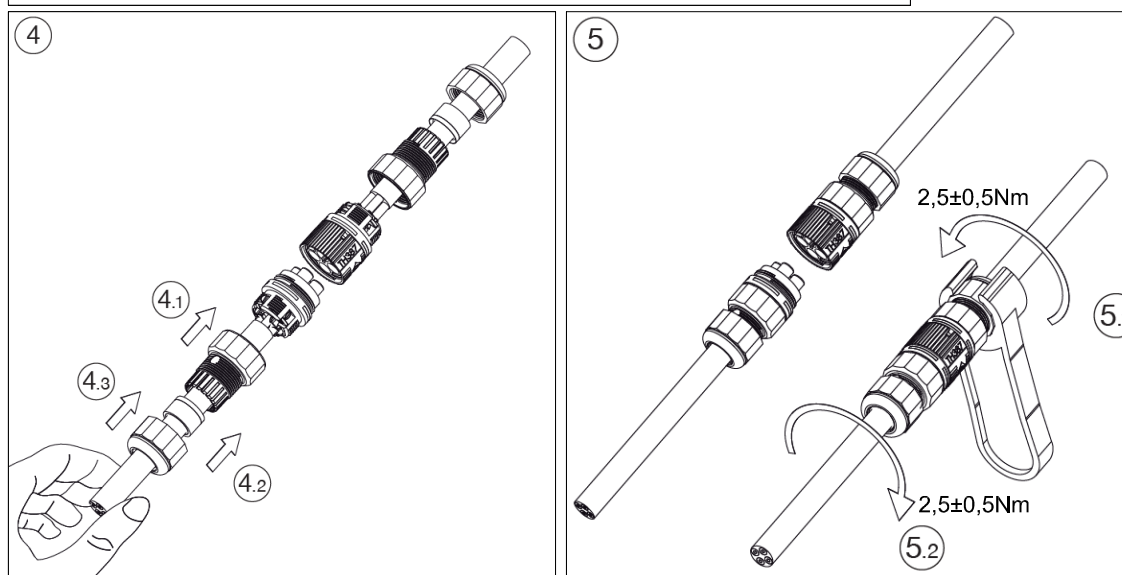
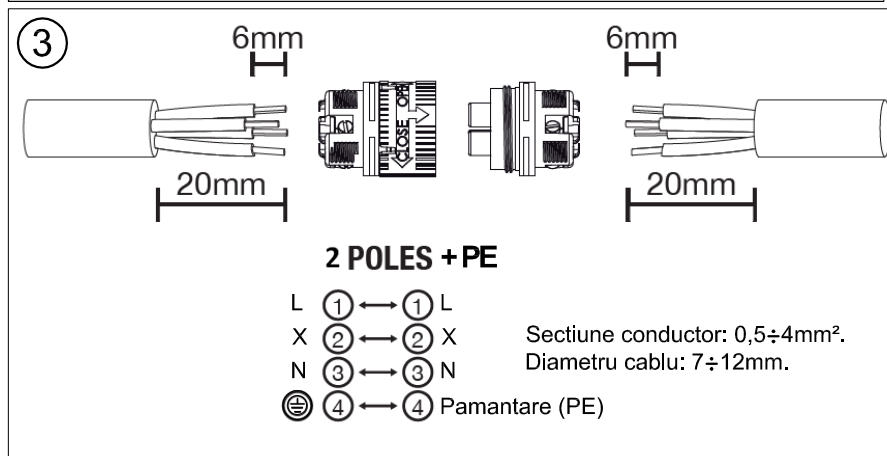
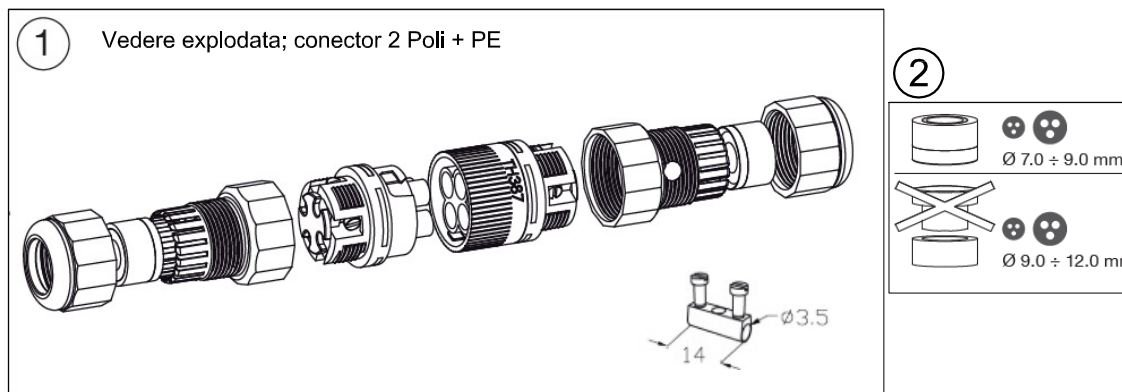

Atentie, risc de soc electric!  
Toate operatiile de montare si intretinere in exploatare se vor efectua in lipsa tensiunii electrice si numai de catre persoane autorizate!  
Sursa de lumina continuta in acest corp de iluminat va fi inlocuita numai de producator sau de agentul sau de service sau de o persoana calificata similara.  
Caution, risk of electric shock!  
All installation and maintenance operations will be performed in absence of operating voltage and only by authorized personnel!  
The light source contained in this luminaire shall only be replaced by the manufacturer or his service agent or a similar qualified person.

Acest simbol aplicat pe produs este in conformitate cu Directiva Europeana 2002/96/CE, privind deseurile echipamentelor electrice si electronice rezultate din dezmembrarea produselor uzate si indica faptul ca produsul face obiectul unei colectari separate. Pentru prevenirea distrugerii mediului inconjurator si sanatatii umane, va rugam sa nu eliminati acest produs ca deșeu nesortat. In vederea unei reciclari sigure din punct de vedere al mediului, utilizatorii de echipamente electrice si electronice trebuie sa predea deseurile acestora la punctele de colectare selectiva special amenajate de catre autoritatile administratiei publice locale.  
This symbol applied on the product complies with European Directive 2002/96/EC, regarding electrical and electronic waste products resulting from the dismantling and indicates that the product has a separate collection. To prevent the damages to the environment and human health, do not dispose of this product as unsorted waste. For a safe recycling, the electric and electronic equipment end-users must contact the local authorities for details concerning a safe recycling.